

The information provided herein is from CONNELY Electronic Co., Ltd. and is confidential. Any disclosure to a party other than the recipient is prohibited. The intellectual properties and its rights contained herein, including but not limited to, trademarks, patents, copyrights, trade secrets, and technical know-how, are owned exclusively by CONNELY or its affiliates. Unauthorized use of this information in any format or manner. CONNELY may enforce its intellectual property rights at its own discretion; failures or delays to exercise such rights does not constitute a waiver of such rights.

1                      2                      3                      4                      5                      6                      7                      8

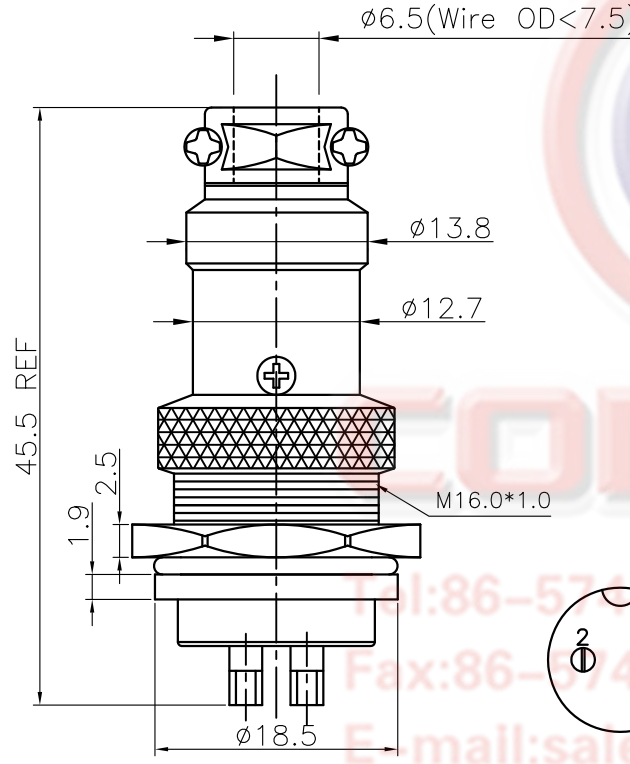

REV.	DESCRIPTION	DRAWN	CHECKED	APPROVED
A	NEW RELEASE	JLZ 05/20/17'	HZW 05/20/17'	LJC 05/20/17'
B	DRAWING UPDATE	JLZ 11/10/18'		

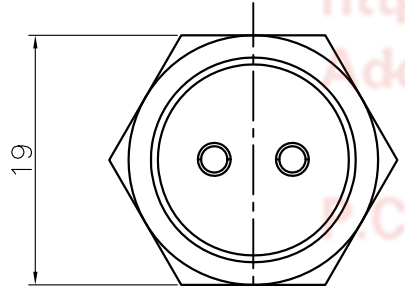
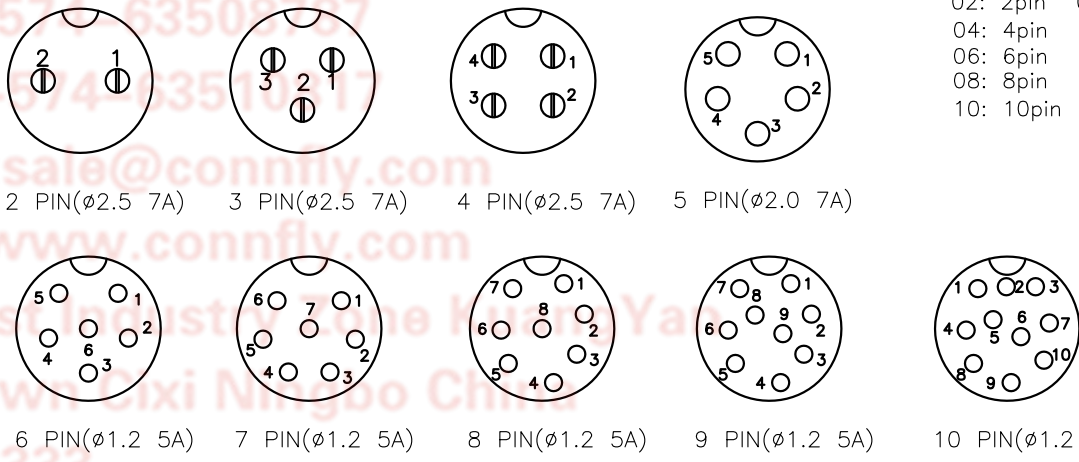
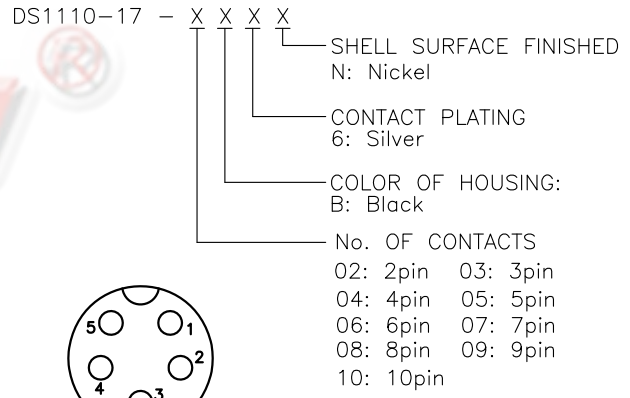

NOTES:

- SPECIFICATION
  - CURRENT RATING: 5A~7A.
  - DIELECTRIC WITH STANDING VOLTAGE: 1000V(AC)
  - CONTACT RESISTANCE: 20mΩ Max.
  - INSULATION RESISTANCE: 1000MΩ(DC)Min
- PRODUCT NUMBER CODE:



GENERAL TOLERANCE		ANGLE TOLERANCE		PROJECTION		TITLE	Micro Jack Total Length=45.5mm Ref
X.	±0.60	X.	±5°	UNITS	mm	(Pin φ1.2~2.5) Threaded Type	
.X	±0.38	.X	±3°	SHEET SIZE	A4	SERIES	DS1110-17 SERIES
.XX	±0.25	.XX	±2°	 <b>晨翔电子有限公司</b> <b>CONNFLY CONNELY ELECTRONIC CO. LTD</b>			
DRAWING TYPE		CUSTOMER					
SCALE	1:1	SHEET	1 OF 1				
DRAWING NO.		C-DS1110-17-XXX-B					

1                      2                      3                      4                      5                      6                      7                      8