

REV.	DESCRIPTION	DRAWN	CHECKED	APPROVED
A	NEW RELEASE	LL 07/07/06'		LJC 07/07/06'
B	DRAWING UPDATE	JLZ 07/13/16'		

Female TERMINAL
(For Male Housing)

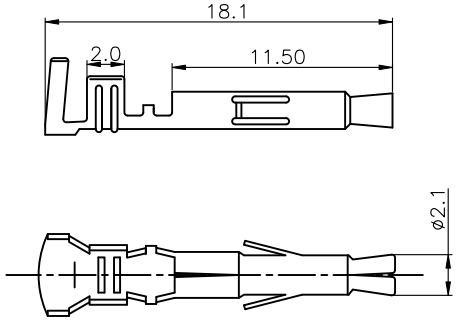

MALE Terminal

Wire Range		O.D of Wire
Section Area (mm ²)	AWG#	mm
0.13~1.25	26~16	1.3~2.7

NOTES:

- MAIN SPECIFICATIONS
 - Housing material: NYLON 66
 - Wire range: AWG#26~#16
 - Rated voltage: 300V
 - Rated current: 1A
 - Contact resistance: $\leq 0.03\Omega$
 - Insulation resistance: $\geq 1000M\Omega$
 - Withstanding voltage: 500V,AC 1 minute
 - Temperature range: -25 ~ +85°C
 - Recommend PC board thickness:1.6~2.0mm
- PRODUCT NUMBER CODE:

Terminal:

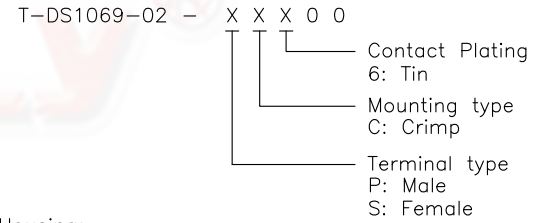

Male TERMINAL
(For Female Housing)

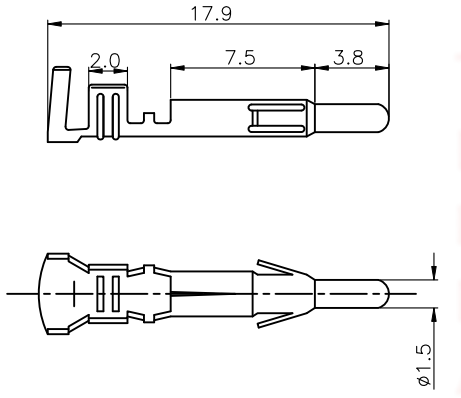

Female Terminal

Wire Range		O.D of Wire
Section Area (mm ²)	AWG#	mm
0.13~1.25	26~16	1.3~2.7

Housing:

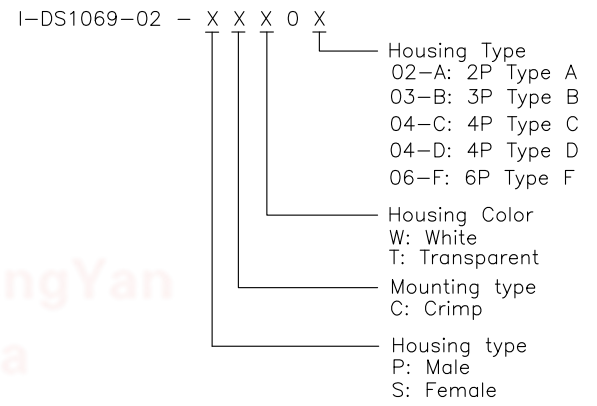

GENERAL TOLERANCE		ANGLE TOLERANCE		PROJECTION		TITLE	P.C.B CONNECTOR 4.5mm EL TYPE	
X.	±0.60	X.	±5°	UNITS	mm			
.X	±0.38	.X	±3°	SHEET SIZE	A4	SERIES	DS1069-02	SERIES
.XX	±0.25	.XX	±2°					
DRAWING TYPE		CUSTOMER			晨翔电子有限公司 CONNFLY CONNFLY ELECTRONIC CO. LTD			
SCALE		1:1	SHEET 1 OF 2					
DRAWING NO.		C-DS1069-02-XXXXX-B						

FEMALE
(For Male Terminal)

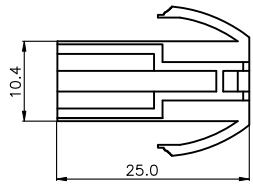

ELR-02P Housing type A

MALE
(For Female Terminal)

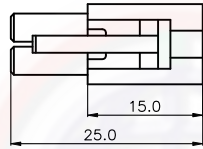
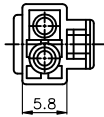

ELR-04P Housing type D

FEMALE
(For Male Terminal)

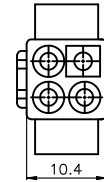
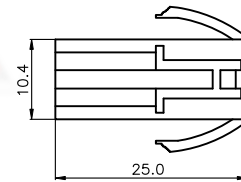

MALE
(For Female Terminal)

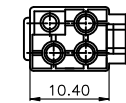

FEMALE
(For Male Terminal)

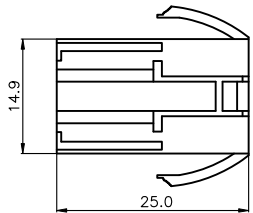

ELR-03P Housing type B

MALE
(For Female Terminal)

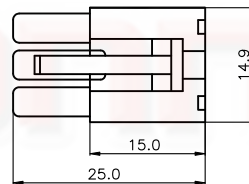
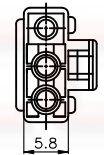

ELR-06P Housing type F

FEMALE
(For Male Terminal)

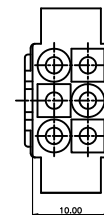
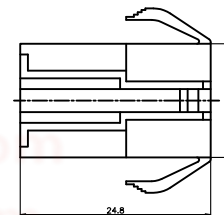

MALE
(For Female Terminal)

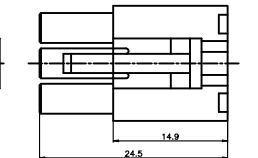
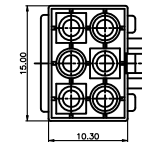

FEMALE
(For Male Terminal)

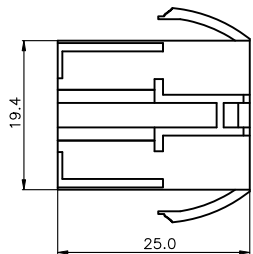

ELR-04P Housing type C

MALE
(For Female Terminal)

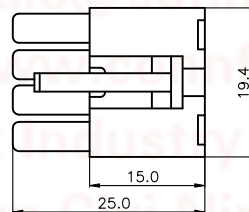
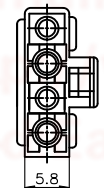

GENERAL TOLERANCE

X. ±0.60
.X ±0.38
.XX ±0.25

ANGLE TOLERANCE

X. ±5°
.X ±3°
.XX ±2°

PROJECTION



TITLE

P.C.B CONNECTOR 4.5mm EL TYPE

UNITS

mm

SHEET SIZE

A4

SERIES

DS1069-02 SERIES

DRAWING TYPE

CUSTOMER

SCALE

1:1

SHEET

2 OF 2

DRAWING NO.

C-DS1069-02-XXXXX-B



晨翔电子有限公司

CONNFLY CONNFLY ELECTRONIC CO. LTD