

Dept	
Qty	
DC	1
ED	1
IE	1
ISO	1
PD	1
R&D	1
SD	1
QA	1
QC	1
QE	1

The information provided herein is from CONNELY Electronic Co., Ltd. and is confidential. Any disclosure to a party other than the recipient is prohibited. The intellectual properties and its rights contained herein, including but not limited to, trademarks, patents, copyrights, trade secrets, and technical know-how, are owned exclusively by CONNELY or its affiliates. Unauthorized use or reproduction of any part of this document is strictly prohibited. CONNELY may enforce its intellectual property rights at its own discretion, failures or delays to exercise such rights does not constitute a waiver of such rights.

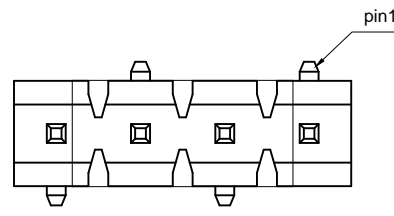

R2 Type

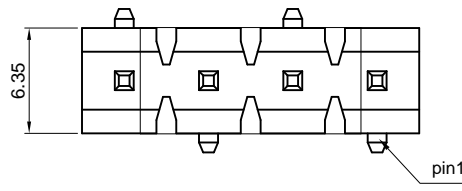

R1 Type

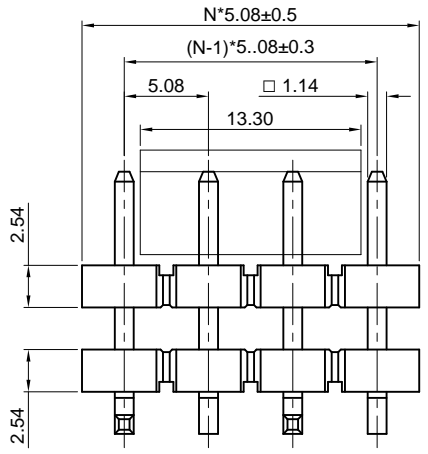

N=No. of contacts

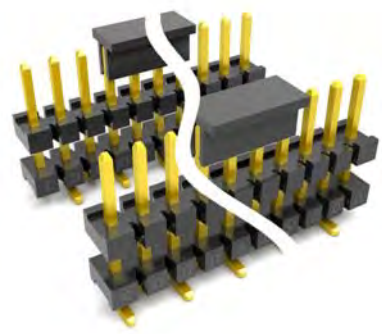

(Series Image-Reference Only)

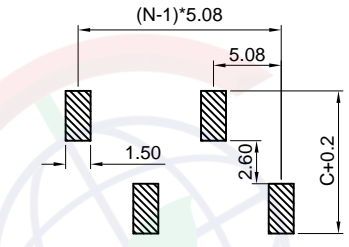
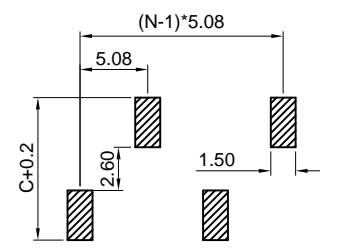

Recommend PCB layout (Tolerance:±0.05)

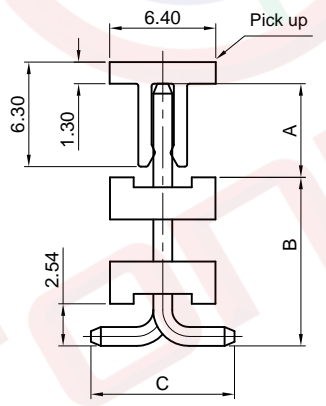

Table A:

Type	Dimension		
	A	B	C
1	5.64	10.16	8.64

REV.	DESCRIPTION	DRAWN	CHECKED	APPROVED
A	NEW RELEASE	YCH 05/09/12'		LJC 05/09/12'
B	DRAWING UPDATE	JLZ 08/14/20'		

NOTES:

Specifications:

- Contact resistance: 20mΩ Max.
- Insulation resistance: 1000MΩ Min.
- Dielectric withstanding voltage: 1000V AC(Rms) for 1 minute.
- Current rating:7A.
- Voltage rating:250V AC Rms.
- Temperature: -40°C~+105°C.

Materials:

- Contact material: Copper alloy.
- Contact plating: Gold plating over nickel.
- Insulator material: High temp,Black,UL94-V0.

Product number code:

DS1029-14 - X X X X X X X X - X

- Plating level  
3A:Level 3A  
B:Level B
- Packing type  
B: Tube  
R: Tape on reel
- Pick up support  
S: W/ pick up  
X: W/O pick up
- Bend type  
A: R1 type  
B: R2 type
- Dim. A B C type  
1: Type 1  
or A\*.\*B\*.\*C\*.\*
- Mounting type  
V: Upright SMT type
- Housing color  
B:Black
- Contact plating  
8: Full gold flash  
6: Full tin
- Connector type  
P:Plug
- No. of contacts  
1x2 - 1x20

GENERAL TOLERANCE	ANGLE TOLERANCE	PROJECTION		TITLE	5.08mm Pin Header Single Row Stack SMT Type
X. ±0.60	X. ±5°	UNITS	mm	SHEET SIZE	A4
.X ±0.38	.X ±3°	SHEET SIZE	A4	SERIES	DS1029-14 SERIES
.XX ±0.25	.XX ±2°	晨翔电子有限公司 <b>CONNFLY CONNELY ELECTRONIC CO. LTD</b>			
DRAWING TYPE	CUSTOMER				
SCALE	1:1				
DRAWING NO.	C-DS1029-14-XXXXXXXX-X-B				