

The information provided herein is from CONNELY Electronic Co., Ltd. and is confidential. Any disclosure to a party other than the recipient is prohibited. The intellectual properties and its rights contained herein, including but not limited to, trademarks, patents, copyrights, trade secrets, and technical know-how, are owned exclusively by CONNELY or its affiliates. Unauthorized use of this information in any format or manner. CONNELY may enforce its intellectual property rights at its own discretion; failures or delays to exercise such rights does not constitute a waiver of such rights.

1 2 3 4 5 6 7 8

Dept	
Qty	
DC	1
ED	1
IE	1
ISO	1
PD	1
R&D	1
SD	1
QA	1
QC	1
QF	1

A B C D E F G H

REV.	DESCRIPTION	DRAWN	CHECKED	APPROVED
A	NEW RELEASE	JLZ 05/07/18'		
B	DRAWING UPDATE	JLZ 09/12/20'		
C	DRAWING UPDATE	JLZ 07/30/24'		

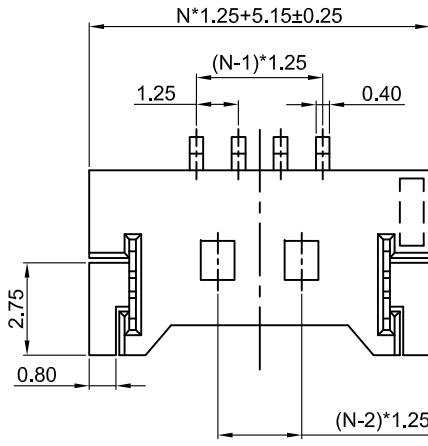

N=No. of contacts
N>10, N is Even

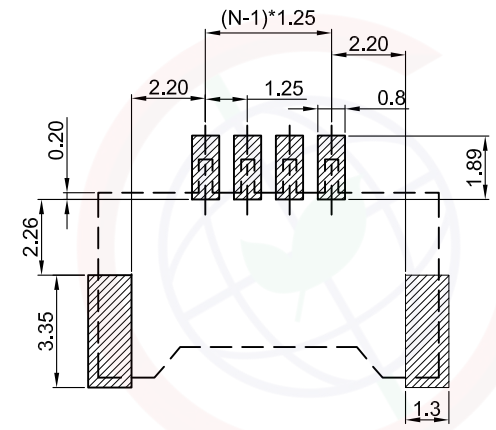
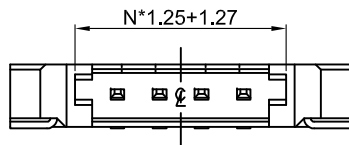

Recommend PCB layout(Tolerance:±0.05)

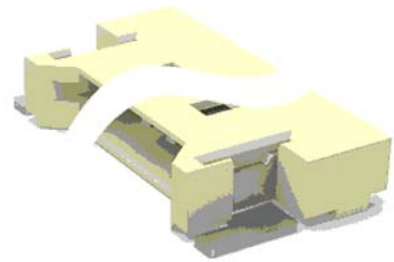
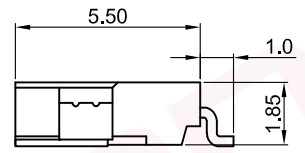

(Series Image-Reference Only)

NOTES:

- Material
 - Insulator:Thermoplastic(UL 94V-0).
 - Contact: Copper alloy.
- Specification
 - Temperature range:-25~+85°C.
 - Contact resistance:20mΩ max.
 - Insulation resistance:500MΩ min.
 - Dielectric withstanding voltage:AC 250V per minute.

3. Product number code:

DS1147-06- X X X X 0 X 0

- X X X X 0 X 0
- Packing type
R: Tape on reel
B: Tube
- Housing color
V:Ivory
- Contact plating
8: Gold flash
- Mounting type
S: SMT type
- Connector type
M: Male
- No. of contacts
02~12

GENERAL TOLERANCE		ANGLE TOLERANCE		PROJECTION		TITLE	1.25mm Wafer Connector SMT Type
X.	±0.60	X.	±5°	UNITS	mm	SHEET SIZE	A4
.X	±0.38	.X	±3°			SERIES	DS1147-06 SERIES
.XX	±0.25	.XX	±2°				
DRAWING TYPE		CUSTOMER		晨翔电子有限公司 CONNELY CONNELY ELECTRONIC CO. LTD			
SCALE		1:1					
DRAWING NO.		C-DS1147-06-XXXXXX-C					

1 2 3 4 5 6 7 8

The information provided herein is from CONNELY Electronic Co., Ltd. and is confidential. Any disclosure to a party other than the recipient is prohibited. The intellectual properties and its rights contained herein, including but not limited to, trademarks, patents, copyrights, trade secrets, and technical know-how, are owned exclusively by CONNELY or its affiliates. Unauthorized use of this information in any format or manner. CONNELY may enforce its intellectual property rights at its own discretion; failures or delays to exercise such rights does not constitute a waiver of such rights.

1 2 3 4 5 6 7 8

REV.	DESCRIPTION	DRAWN	CHECKED	APPROVED
A	NEW RELEASE	JLZ 05/07/18'		
B	DRAWING UPDATE	JLZ 09/12/20'		
C	DRAWING UPDATE	JLZ 07/30/24'		

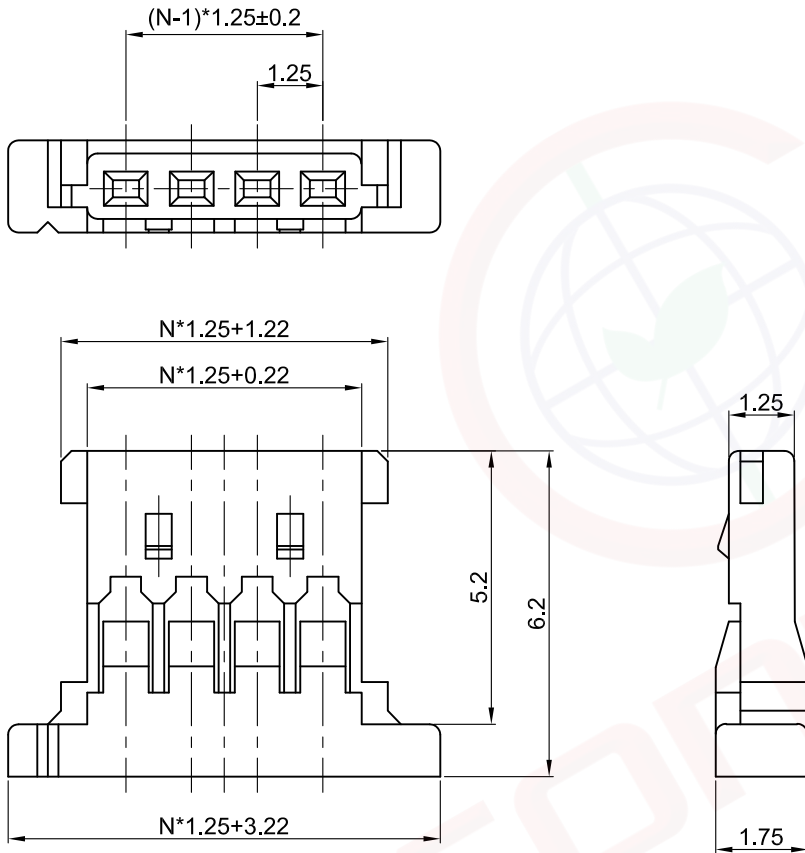

N=No.of Housing
N>10, N is Even



(Series Image-Reference Only)

Notes:

- 1.Material: Nylon,Color:Nature.
- 2.Current Rating:1.0A AC/DC.
- 3.Voltage Rating:125V AC/DC.
- 4.Temperature Range:-25~+85°C.
- 5.Part Number Code:

I - DS1147-06 - S C X 0 X

No.of Housing
02~12

Housing Color
W:Ivory

GENERAL TOLERANCE		ANGLE TOLERANCE		PROJECTION		TITLE	1.25mm Connector Housing H=1.75mm	
X.	±0.60	X.	±5°	UNITS	mm			
.X	±0.38	.X	±3°	SHEET SIZE	A4	SERIES	DS1147-06 SERIES	
.XX	±0.25	.XX	±2°					
DRAWING TYPE		CUSTOMER						
SCALE		1:1	SHEET		2 OF 3			
DRAWING NO.		C-DS1147-06-XXXXXX-C						

晨翔电子有限公司
CONNELY CONNELY ELECTRONIC CO. LTD

1 2 3 4 5 6 7 8

Dept	
Qty	
DC	1
ED	1
IE	1
ISO	1
PD	1
R&D	1
SD	1
QA	1
QC	1
QF	1

The information provided herein is from CONNELY Electronic Co., Ltd. and is confidential. Any disclosure to a party other than the recipient is prohibited. The intellectual properties and its rights contained herein, including but not limited to, trademarks, patents, copyrights, trade secrets, and technical know-how, are owned exclusively by CONNELY or its affiliates. Unauthorized use or reproduction of any part of this document is strictly prohibited. CONNELY may enforce its intellectual property rights at its own discretion, failures or delays to exercise such rights does not constitute a waiver of such rights.

REV.	DESCRIPTION	DRAWN	CHECKED	APPROVED
A	NEW RELEASE	JLZ 05/07/18'		
B	DRAWING UPDATE	JLZ 09/12/20'		

- Notes:
1. Material: Copper Alloy, Gold Plated.
 2. Current Rating: 1.0A AC/DC.
 3. Voltage Rating: 125V AC/DC.
 4. Temperature Range: -25~+85°C.
 5. Part Number Code:

T - DS1147-06 - S C X 0 0

Plating Type
8: Gold flash

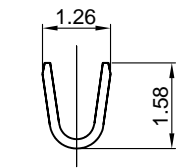
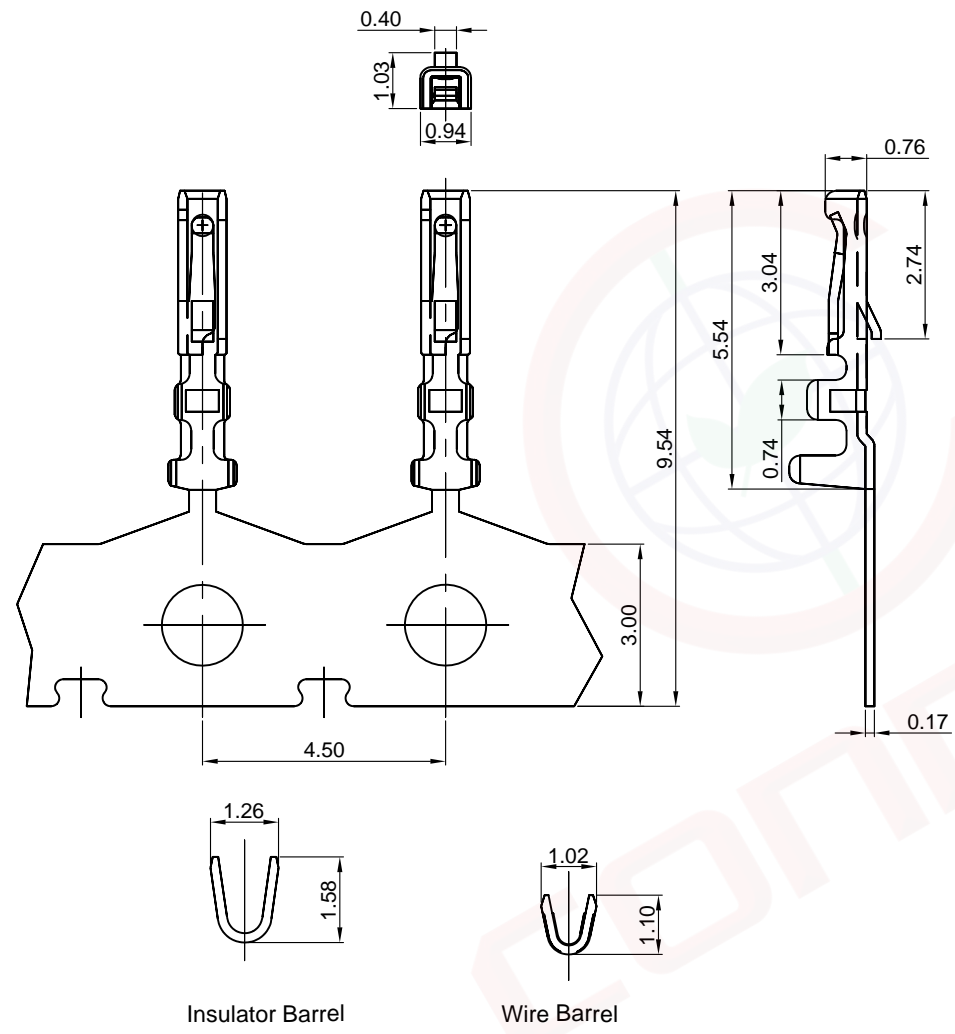

Insulator Barrel

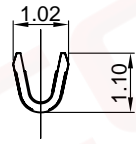

Wire Barrel



(Series Image-Reference Only)

GENERAL TOLERANCE		ANGLE TOLERANCE	
X.	±0.60	X.	±5°
.X	±0.38	.X	±3°
.XX	±0.25	.XX	±2°
DRAWING TYPE		CUSTOMER	
SCALE	1:1	SHEET	3 OF 3
DRAWING NO.	C-DS1147-06-XXXXXX-B		

PROJECTION		TITLE	1.25mm Connector Terminal	
UNITS	mm			
SHEET SIZE	A4	SERIES	DS1147-06 SERIES	

晨翔电子有限公司
CONNFLY CONNELY ELECTRONIC CO. LTD